

# OPERATING GUIDE

## Ultra™ 60/120 Vacuum Tube Amplifier





Intended to alert the user to the presence of uninsulated “dangerous voltage” within the product’s enclosure that may be of sufficient magnitude to constitute a risk of electric shock to persons.



Intended to alert the user to the presence of important operating and maintenance (servicing) instructions in the literature accompanying the product.

**CAUTION** Risks of electrical shock — DO NOT OPEN

**CAUTION** To reduce the risk of electric shock, do not remove cover. No user serviceable parts inside. Refer Servicing to qualified service personnel.

**WARNING** To prevent electrical shock or fire hazard, do not expose this appliance to rain or moisture. Before using this appliance, read the operating guide for further warnings.



Este símbolo tiene el propósito de alertar al usuario de la presencia de instrucciones importantes sobre la operación y mantenimiento en la literatura que viene con el producto.



Este símbolo tiene el propósito de alertar al usuario de la presencia de “(voltaje) peligroso” que no tiene aislamiento dentro de la caja del producto que puede tener una magnitud suficiente como para constituir riesgo de corrientazo.

**PRECAUCION** Riesgo de corrientazo - No abra.

**PRECAUCION** Para disminuir el riesgo de corrientazo, no abra la cubierta. No hay piezas adentro que el usuario pueda reparar. Deje todo mantenimiento a los técnicos calificados.

**ADVERTENCIA** Para evitar corrientazos o peligro de incendio, no deje expuesto a la lluvia o humedad este aparato. Antes de usar este aparato, lea más advertencias en la guía de operación.



Ce symbole est utilisé pour indiquer à l'utilisateur qu'il ou qu'elle trouvera d'importantes instructions sur l'utilisation et l'entretien (service) de l'appareil dans la littérature accompagnant le produit.



Ce symbole est utilisé pour indiquer à l'utilisateur la présence à l'intérieur de ce produit de tension non-isolée dangereuse pouvant être d'intensité suffisante pour constituer un risque de choc électrique.

**ATTENTION** Risques de choc électrique — NE PAS OUVRIR!

**ATTENTION** Afin de réduire le risque de choc électrique, ne pas enlever le couvercle. Il ne se trouve à l'intérieur aucune pièce pouvant être réparée par l'utilisateur. Confier l'entretien à un personnel qualifié.

**AVERTISSEMENT** Afin de prévenir les risques de décharge électrique ou de feu, n'exposez pas cet appareil à la pluie ou à l'humidité. Avant d'utiliser cet appareil, lisez les avertissements supplémentaires situés dans le guide d'utilisation.



Dieses Symbol soll den Benutzer auf wichtige Instruktionen in der Bedienungsanleitung aufmerksam machen, die Handhabung und Wartung des Produkts betreffen.



Dieses Symbol soll den Anwender vor unisolierten gefährlichen Spannungen innerhalb des Gehäuses warnen, die von Ausreichender Stärke sind, um einen elektrischen Schlag verursachen zu können.

**VORSICHT** Risiko - Elektrischer Schlag! Nicht öffnen!

**VORSICHT** Um das Risiko eines elektrischen Schlages zu vermeiden, nicht die Abdeckung entfernen. Es befinden sich keine Teile darin, die vom Anwender repariert werden könnten. Reparaturen nur von qualifiziertem Fachpersonal durchführen lassen.

**ACHTUNG** Um einen elektrischen Schlag oder Feuergefahr zu vermeiden, sollte dieses Gerät nicht dem Regen oder Feuchtigkeit ausgesetzt werden. Vor Inbetriebnahme unbedingt die Bedienungsanleitung lesen.

# ENGLISH

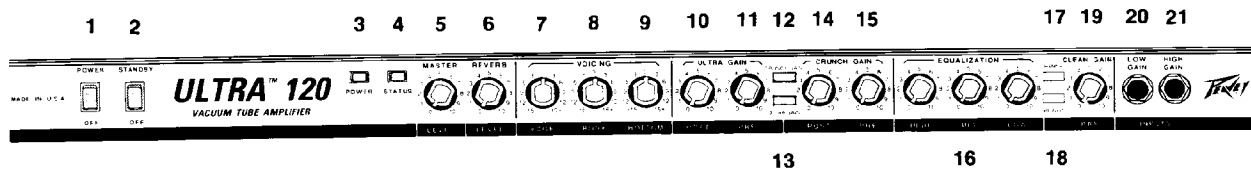

## **POWER SWITCH (1)**

Depress the switch to the “On” position. The red pilot light (LED) will illuminate indicating power is being supplied to the unit.

## **STANDBY SWITCH (2)**

Allows amp to be placed in standby or active mode. In standby mode the tubes remain hot, but the amplifier is not operational.

## **POWER LED (3)**

Illuminates when AC power is being supplied to the amp.

## **STATUS LED (4)**

Illuminates when amp is switched to standby indicating amplifier is not operational.

## **MASTER LEVEL (5)**

Controls the overall volume level of the system. Once a desired balance of the Clean, Crunch, and Ultra channels is achieved, the entire system level may be increased or decreased with the Master Level Control.

## **REVERB LEVEL (6)**

Reverberation is an echo effect. Rotate clockwise to increase the effect. Remote footswitch can control On/Off.

## **EDGE (7)**

An active tone control (shelving type,  $\pm 15$  dB) that varies the high frequency boost or cut.

**NOTE:** This control is not functional on the Clean channel.

## **BODY (8)**

An active tone control (peak/notch,  $\pm 15$ dB) that varies the mid frequency boost or cut.

**NOTE:** This control is not functional on the Clean channel.

## **BOTTOM (9)**

An active tone control (shelving type  $\pm 15$  dB) that varies the low frequency boost or cut.

**NOTE:** This control is not functional on the Clean channel.

## **POST GAIN (10)**

Controls the overall volume level of the channel. The final level adjustment should be made after the desired sound has been achieved.

## **PRE GAIN (11)**

Controls the input volume level of the channel.

## **CRUNCH GAIN SWITCH (12)**

Boosts the overall system gain of the crunch channel. Depress to the “in” position to activate.

### ULTRA GAIN SWITCH (13)

Boosts the overall system gain of the Ultra channel. Depress to the “in” position to activate.

### POST GAIN (14)

Controls the overall volume level of the channel. The final level adjustment should be made after the desired sound has been achieved.

### PRE GAIN (15)

Controls the input volume level of the channel.

### LOW, MID, & HIGH EQ (16)

Passive tone controls that regulate the low, mid and high frequencies, respectively.

### CHANNEL SELECT SWITCH (17)

Allows selection of the Ultra or Clean channel and the “out” position selects Clean.

**NOTE:** Channel selection may also be accomplished by the remote footswitch. If remote selection is desired, the channel switch must be in the “in” (Ultra) position.

### BRIGHT SWITCH (18)

Provides a preset boost to treble frequencies. To activate, depress the switch to its “in” position. The bright function affects only the Clean channel.

### CLEAN GAIN (19)

Controls the channel volume.

### LOW GAIN INPUT (20)

Provided for instruments that have extremely high outputs, which can result in overdriving (distorting) the High Gain input. If both inputs are used simultaneously, the output levels are the same (both are Low Gain).

### HIGH GAIN INPUT (21)

Used for most electric guitars. It is 6 dB louder than the Low Gain input.

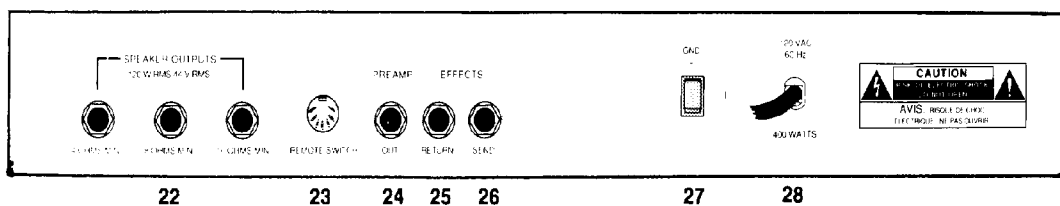

### SPEAKER OUTPUTS (22)

Speaker output ( $\frac{1}{4}$ " ) jacks are provided for 4 ohms, 8 ohms, and 16 ohms. When the 8 and 16 ohm jacks are engaged, amplifier impedance is 8 ohms. When the 4 and 8 ohm jacks are engaged, amplifier impedance is 4 ohms.

### REMOTE FOOTSWITCH JACK (23)

Provided for the connection of the supplied remote footswitch. Footswitch is used to select the Ultra Gain, Crunch Gain, or Normal Channels and defeat reverb.

**PREAMP OUT (24)**

The preamp output can be used to route the amplified signal to a mixing console, tape recorder, etc. Connect the preamp output using a shielded cable to an input of the tape recorder, mixer, etc. This patch does not affect the operation of the amplifier.

**EFFECTS RETURN (25)**

Input for returning signals from external low-level effects or signal processing equipment.

**EFFECTS SEND (26)**

Output for supplying signals to external low-level effects or signal processing equipment.

**GROUND SWITCH (27)**

Three position rocker-type switch which, in most applications, should be operated in its center or zero position. There may be some situations when audible hum and/or noise will come from the loudspeaker. If this situation arises, position the ground switch to either positive or negative ( + or -) or until the noise is minimized.

**NOTE:** Should the noise problem continue, consult your Authorized Peavey Dealer, the Peavey Factory, or a qualified service technician. **THE GROUND SWITCH IS NOT FUNCTIONAL ON 220/240 VOLT MODELS.**

**LINE CORD (120V PRODUCTS ONLY) (28)**

For your safety, we have incorporated a 3-wire line (mains) cable with proper grounding facilities. It is not advisable to remove the ground pin under any circumstances. If it is necessary to use the equipment without proper grounding facilities, suitable grounding adaptors should be used. Less noise and greatly reduced shock hazard exists when the unit is operated with the proper grounded receptacles.

## TONE SETTINGS

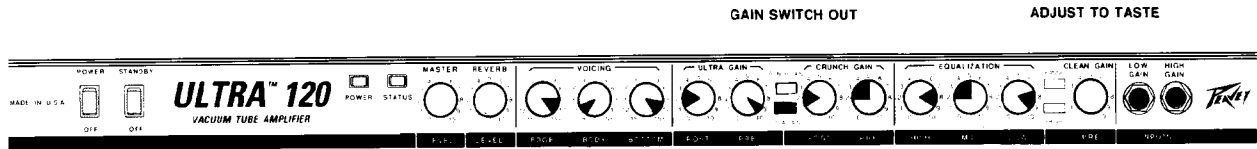

ADJUST TO TASTE
GAIN SWITCH IN
ADJUST TO TASTE

**METAL**
**MILD DISTORTION**
**CLEAN**

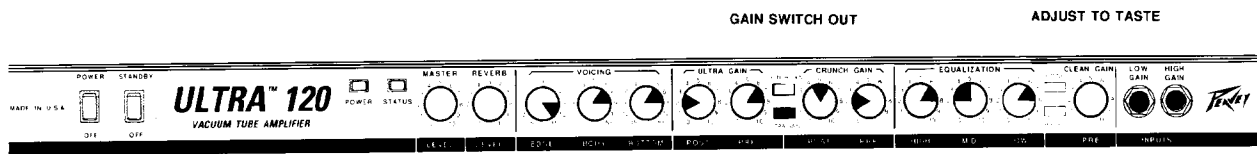

ADJUST TO TASTE
GAIN SWITCH OUT
BRIGHT SWITCH IN

**COUNTRY/ROCK LEAD**
**MILD RHYTHM DISTORTION**
**COUNTRY CLEAN**

Tone settings given are general and will vary according to type of guitar, type and gauges of strings, type of pickup and even type of pick. Personal taste, playing style and type of music greatly contribute to desired tonality.

### BLOCK DIAGRAM

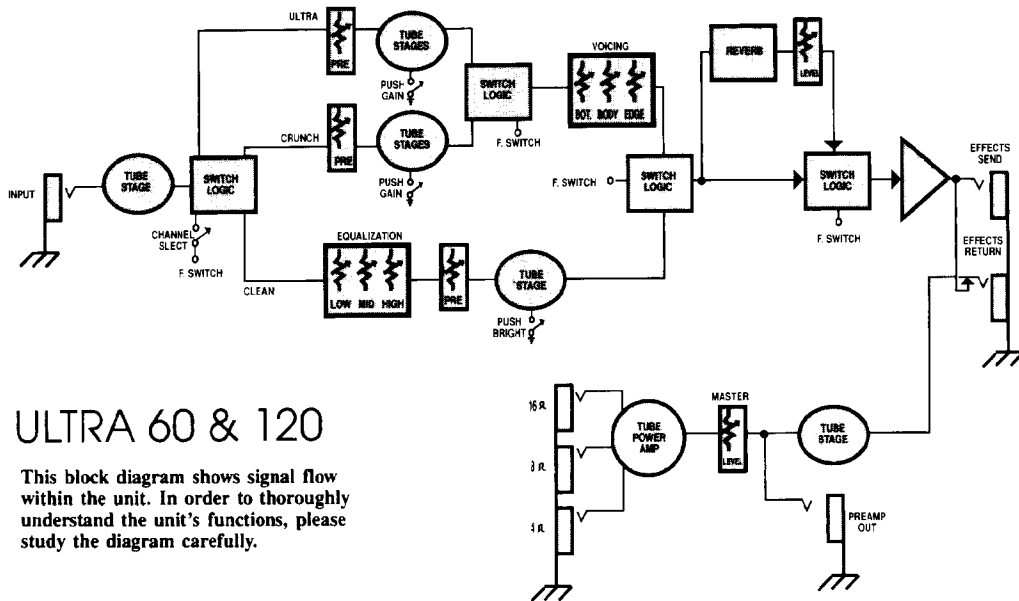

### ULTRA 60 & 120

This block diagram shows signal flow within the unit. In order to thoroughly understand the unit's functions, please study the diagram carefully.

## SPECIFICATIONS

### Ultra™ 60

#### POWER AMP SECTION:

2 - 6L6GC's with 12AX7 driver

#### Rated Power & Load:

60 W RMS into 16, 8, or 4 ohms

#### Power @ Clipping:

(Typically @ 5% THD, 1 kHz, 120 V AC line) 65 W RMS into 16, 8, or 4 ohms  
(Bias must be reduced to measure)

#### Frequency Response:

+0, -2 dB 50 Hz to 20 kHz @ 50 W RMS into 8 ohms

#### Hum & Noise:

Greater than 76 dB below rated power

#### Power Consumption:

200 Watts, 50/60 Hz, 120 V AC (Domestic)

#### PREAMP SECTION:

3 - 12AX7's

The following specs are measured @ 1 kHz with the controls preset as follows:

Low & High EQ @ 10, Mid EQ @ 0, Bright out  
Ultra & Crunch Posts @ 10, Gain switches out  
Bottom, Body, & Edge @ 0 dB  
Reverb level @ 0, Master level @ 10

(Nominal levels are with Pre Gains @ 5)

(Minimum levels are with Pre Gains @ 10)

#### Preamp High Gain Input:

Impedance: Very high Z, 470 K ohm

#### Ultra Channel:

##### (with channel-select in)

Nominal Input Level: -46 dBV, 5 mV RMS  
Minimum Input Level: -64 dBV, 0.6 mV RMS  
(Subtract 15 dB with gain switch in)

#### Crunch Channel: (footswitch selected)

Nominal Input Level: -34 dBV, 20 mV RMS  
Minimum Input Level: -52 dBV, 2.5 mV RMS  
(Subtract 15 dB with gain switch in)

#### Clean Channel:

##### (with channel-select out)

Nominal Input Level: -16 dBV, 150 mV RMS  
Minimum Input Level: -34 dBV, 20 mV RMS  
Maximum Input Level: 0 dBV, 1.0 V RMS

#### Preamp Low Gain Input: (-6 dB Pad)

Impedance: High Z, 44 K ohms  
All levels are increased by +6 dB

#### Effects Send:

Load Impedance: 47 K ohms or greater  
Nominal Output: -10 dBV, 300 mV RMS

#### Effects Return:

Impedance: Very high Z, 470 K ohm  
Designed Level: -10 dBV, 300 mV RMS

#### Preamp Output:

Load Impedance: 47 K ohms or greater  
Nominal Output: +10 dBV, 3 V RMS

#### Remote Footswitch:

Special 3 button unit with LED indicators (supplied)

#### Systems Hum & Noise @

##### Nominal Level:

##### (Clean channel)

(20 Hz to 20 kHz unweighted)  
Greater than 74 dB below rated power (Special noise gate circuitry for Ultra & Crunch)

#### Equalization:

##### (Clean channel only)

Custom Low, Mid, & High passive type EQ  
Push Bright: +6 dB @ 2 kHz

#### Voicing: (Ultra and Crunch channels only):

Active Bottom, Body, and Edge EQ  
Push Gain: Increases gain in Ultra and Crunch channels.

### Ultra™ 120

#### POWER AMP SECTION:

4 - 6L6GC's with 12AX7 driver

#### Rated Power & Load:

120 W RMS into 16, 8, or 4 ohms

#### Power @ Clipping:

(Typically @ 5% THD, 1 kHz, 120 V AC line) 130 W RMS into 16, 8, or 4 ohms  
(Bias must be reduced to measure)

#### Frequency Response:

+0, -2 dB 50 Hz to 20 kHz @ 100 W RMS into 8 ohms

#### Hum & Noise:

Greater than 76 dB below rated power

#### Power Consumption:

400 Watts, 50/60 Hz, 120 V AC (Domestic)

## **SPECIFICATIONS (continued)**

### **PREAMP SECTION:**

3 - 12AX7's

The following specs are measured @  
1 kHz with the controls preset as follows:

Low & High EQ @ 10, Mid EQ  
@ 0, Bright out  
Ultra & Crunch Posts @ 10,  
Gain switches out  
Bottom, Body, & Edge @ 0 dB  
Reverb level @ 0, Master level  
@ 10

(Nominal levels are with Pre Gains  
@ 5)

(Minimum levels are with Pre  
Gains @ 10)

### **Preamp High Gain Input:**

Impedance: Very high Z,  
470 K ohm

### **Ultra Channel: (with channel-select in)**

Nominal Input Level: -46 dBV,  
5 mV RMS  
Minimum Input Level: -64 dBV,  
0.6 mV RMS  
(Subtract 15 dB with gain switch  
in)

### **Crunch Channel: (footswitch selected)**

Nominal Input Level: -34 dBV,  
20 mV RMS  
Minimum Input Level: -52 dBV,  
2.5 mV RMS  
(Subtract 15 dB with gain  
switch in)

### **Clean Channel: (with channel-select out)**

Nominal Input Level: -16 dBV,  
150 mV RMS  
Minimum Input Level: -34 dBV,  
20 mV RMS  
Maximum Input Level: 0 dBV,  
1.0 V RMS

### **Preamp Low Gain Input: (-6 dB Pad)**

Impedance: High Z, 44 K ohms  
All levels are increased by  
+6 dB

### **Effects Send:**

Load Impedance: 47 K ohms or  
greater  
Nominal Output: -10 dBV,  
300 mV RMS

### **Effects Return:**

Impedance: Very high Z,  
470 K ohm  
Designed Level: -10 dBV,  
300 mV RMS

### **Preamp Output:**

Load Impedance: 47 K ohms or  
greater  
Nominal Output: +10 dBV, 3 V  
RMS

### **Remote Footswitch:**

Special 3 button unit with LED  
indicators (supplied)

### **Systems Hum & Noise @ Nominal Level: (clean channel)**

(20 Hz to 20 kHz unweighted)  
Greater than 74 dB below rated  
power (Special noise gate cir-  
cuitry for Ultra & Crunch)

### **Equalization: (clean channel only)**

Custom Low, Mid, & High  
passive type EQ  
Push Bright: +6 dB @ 2 kHz

### **Voicing: (Ultra and Crunch channel only):**

Active Bottom, Body, and  
Edge EQ  
Push Gain: Increases gain in  
Ultra and Crunch channels.



# ESPAÑOL

## Consulte los diagramas del panel delantero en la sección de inglés de este manual.

### **POWER SWITCH (Interruptor de corriente) (1)**

Oprima el interruptor a la posición "hacia dentro" (encendido). La luz roja del piloto (indicador) se encenderá indicando que la unidad está recibiendo corriente alterna.

### **STANDBY SWITCH (Interruptor de condición de espera) (2)**

Este interruptor le permite a su aparato estar en condición de "espera" o la condición de activo. En la condición "standby" los tubos permanecen calientes, pero el amplificador no está en operación.

### **POWER LED (LED indicador de corriente) (3)**

Se ilumina cuando el amplificador recibe corriente alterna.

### **STATUS LED (LED indicador de condición) (4)**

Se ilumina cuando el amplificador está en la condición de espera ("standby"), indicando que el amplificador no está en funcionamiento.

### **MASTER LEVEL (Nivel maestro) (5)**

Controla el nivel de volumen global del sistema. Una vez que se logra el balance deseado de los canales "clean", "crujido" y "ultra", el nivel del sistema entero puede aumentarse o disminuirse con el control de nivel maestro.

### **REVERB LEVEL (Reverberación nivel) (6)**

La reverberación es un efecto de eco. Haga girar a la derecha para aumentar el efecto. El encendido/apagado ("on/off") se puede controlar con el pedal interruptor de control remoto.

### **EDGE (Filo) (7)**

Un control de tono activo (de estante,  $\pm 15$  dB) que varía el aumento o disminución de frecuencias bajas.

**NOTA:** Este control no funciona en el canal "Clean".

### **BODY (Cuerpo) (8)**

Es un control de tono activo (cima/gradual,  $\pm 15$  dB) que varía el aumento o disminución de las frecuencias medias.

**NOTA:** Este control no funciona en el canal "Clean".

### **BOTTOM (Fondo) (9)**

Un control de tono activo (gradual  $\pm 15$  dB) que vara el aumento o disminución de frecuencias bajas.

**NOTA:** Este control no funciona en el canal "Clean".

### **POST GAIN (Control de ganancia posterior al preamplificador) (10)**

Controla el nivel global de volumen del canal. El ajuste final de nivel debe hacerse una vez que se haya conseguido el sonido deseado.

### **PRE GAIN (Control del preamplificador) (11)**

Controla el nivel del volumen de la entrada del canal.

### **CRUNCH GAIN SWITCH (Interruptor de ganancia de "crujido") (12)**

Aumenta la ganancia global de sistema del canal "crujido". Oprima a la posición "hacia adentro" para activar.

### **ULTRA GAIN SWITCH (Interruptor de ganancia de "ultra") (13)**

Aumenta la ganancia global de sistema del canal "Ultra". Oprima a la posición "hacia adentro" para activar.

**POST GAIN (Control de ganancia posterior al preamplificador) (14)**

Controla el nivel global de volumen del canal. El ajuste final de nivel debe hacerse una vez que se haya conseguido el sonido deseado.

**PRE GAIN (Control del preamplificador) (15)**

Controla el nivel del volumen de la entrada del canal.

**LOW, MID & HIGH EQ (Ecuador de frecuencias graves, medias y agudas) (16)**

Controles de tono pasivo que regulan las frecuencias graves, medias, y altas, respectivamente.

**CHANNEL SELECT SWITCH (Interruptor de selección de canal) (17)**

Permite la selección del canal “Ultra” o “Limpio” y la posición “hacia afuera” selecciona el canal “limpio”.

**NOTA:** También se pueden seleccionar los canales con el pedal interruptor remoto. Si desea selección a control remoto, el interruptor de canal debe estar en la posición “hacia adentro” (Ultra).

**BRIGHT SWITCH (Interruptor de brillo) (18)**

Proporciona un impulso preajustado a las frecuencias de tiple. Para activar, oprima el interruptor a la posición “hacia adentro”. La función de brillo solamente afecta el canal “limpio”.

**CLEAN GAIN (Ganancia) (19)**

Controla el volumen del canal.

**LOW GAIN INPUT (Entrada de baja ganancia) (20)**

Se suministra para instrumentos que tienen una salida extremadamente alta, la cual puede causar la sobrecarga (distorsión) de la entrada de alta ganancia. Si se usan ambas entradas simultáneamente, el nivel de salida es el mismo (ambos son de baja ganancia).

**HIGH GAIN INPUT (Entrada de ganancia alta) (21)**

Se usa para la mayoría de las guitarras eléctricas. Tiene 6 dB más volumen que la entrada de baja ganancia.



**SPEAKER OUTPUTS (Salidas de altavoces) (22)**

Se proporcionan enchufes hembras para salidas (de ¼ de pulgada) de altavoces para 4 ohmios, 8 ohmios y 16 ohmios. Cuando se utilizan los enchufes hembras de 8 y 16 ohmios, la impedancia del amplificador es de 8 ohmios. Cuando se utilizan los enchufes hembras de 4 y 8 ohmios, la impedancia del amplificador es de 4 ohmios.

**REMOTE FOOTSWITCH JACK (Enchufe hembra del pedal interruptor de control remoto) (23)**

Se suministra para la conexión del pedal interruptor de control remoto. El pedal se utiliza para seleccionar los canales de Ultra Ganancia, Ganancia de Crujido, o Normal.

**PREAMP OUT (Salida de preamplificador) (24)**

La salida del preamplificador puede usarse para mandar la señal a una consola de mezcla, grabadora, etc. Conecte la salida del preamplificador, utilizando un cable blindado, a una entrada de la grabadora, mezclador, etc. Esta interconexión no afecta la operación del amplificador.

**EFFECTS RETURN (Retorno de efectos) (25)**

Entrada para el retorno de señales procedentes de equipos de efectos externos de bajo nivel o de procesadores de señal.

**EFFECTS SEND (Envío de efectos) (26)**

Salida para proporcionar señales a efectos exteriores de bajo nivel o a equipos procesadores de señal.

**GROUND SWITCH (Interruptor de tierra) (27)**

Un interruptor tipo balancín de tres posiciones que, en la mayoría de las aplicaciones, debe ser operado en su posición del centro o cero (0). Puede haber situaciones cuando un zumbido audible salga del altavoz. Si esta situación ocurre, ajuste la posición del interruptor de tierra a positivo o negativo ( + o -) o hasta que el ruido disminuya.

**NOTA:** Si el problema de ruido continúa, consulte su representante autorizado de Peavey, la fábrica de Peavey, o un técnico de servicio calificado. EL INTERRUPTOR DE TIERRA NO FUNCIONA EN LOS MODELOS DE 220/240 VOLTIOS.

**LINE CORD (120 V PRODUCTS ONLY) (Cable de corriente para 120 v solamente) (28)**

Para su protección hemos incorporado un cable de 3 polos con polo a tierra. No es recomendable remover la pata del polo a tierra bajo ninguna circunstancia, se recomienda un adaptador en caso necesario. Esto reducirá ruidos y peligrosos corrientazos.

# FRANÇAIS

**Veillez vous référer au “front panel line art”  
situé dans la section en langue anglaise de ce manuel.**

## **POWER SWITCH (Interrupteur d'alimentation) (1)**

Mettre l'interrupteur en position “On”. La lampe témoin rouge (DEL) s'illumine indiquant que l'appareil est alimenté en courant.

## **STANDBY SWITCH (Sélecteur attente) (2)**

Permet de sélectionner l'état de l'ampli: mode “Active” (actif) ou mode “Standby” (attente). En position “Standby”, l'amplificateur ne fonctionne pas mais les lampes (“tubes”) restent chaudes pour permettre de le remettre en service sans délai.

## **POWER LED (DEL témoin de mise sous tension) (3)**

S'allume lorsque l'ampli reçoit l'alimentation CA.

## **STATUS LED (DEL témoin) (4)**

S'allume lorsque l'ampli est en mode d'attente “Standby” pour indiquer que l'amplificateur n'est pas opérationnel.

## **MASTER LEVEL (Niveau principal) (5)**

Contrôle le niveau de volume global du système. Une fois la balance des canaux “Clean, Crunch”, et “Ultra” établie, le volume du système entier peut être élevé ou diminué à l'aide de la commande “Master Level”.

## **REVERB LEVEL (Réverbération niveau) (6)**

La réverbération est un effet d'écho. Tournez dans le sens du mouvement des aiguilles d'une montre pour augmenter l'intensité de l'effet. L'interrupteur au pied peut contrôler la mise en circuit ou hors circuit (“On/Off”).

## **EDGE (Aiguë) (7)**

Bouton de réglage de tonalité actif (type passe haut,  $\pm 15$  dB) faisant varier la coupure ou l'amplification des fréquences graves.

**NOTE:** Cette commande ne fonctionne pas sur le canal “Clean”.

## **BODY (Corps) (8)**

Bouton de réglage de tonalité actif (correction  $\pm 15$  dB) faisant varier la coupure ou l'amplification des fréquences moyennes.

**NOTE:** Cette commande ne fonctionne pas sur le canal “Clean”.

## **BOTTOM (Grave) (9)**

Bouton de réglage de tonalité actif (type passe bas,  $\pm 15$  dB) faisant varier la coupure ou l'amplification des fréquences graves.

**NOTE:** Cette commande ne fonctionne pas sur le canal “Clean”.

## **POST GAIN (10)**

Commande le volume global du canal. Le réglage final de niveau doit être effectué après avoir obtenu le sonorité désirée à l'aide des autres réglages.

## **PRE GAIN (11)**

Contrôle le niveau de volume à l'entrée du canal.

### **CRUNCH GAIN SWITCH (Interrupteur de gain Crunch) (12)**

Hausse le gain global du canal "Crunch". Abaisser à la position "In" pour activer.

### **ULTRA GAIN SWITCH (Interrupteur de gain Ultra) (13)**

Hausse le gain global du canal "Ultra". Abaisser à la position "In" pour activer.

### **POST GAIN (14)**

Commande le volume global du canal. Le réglage final de niveau doit être effectué après avoir obtenu le sonorité désirée à l'aide des autres réglages.

### **PRE GAIN (15)**

Contrôle le niveau de volume à l'entrée du canal.

### **LOW, MID, & HIGH EQ (Égalisation graves, moyennes et aiguës) (16)**

Réglages de tonalité passifs réglant respectivement les fréquences graves, moyennes et aiguës.

### **CHANNEL SELECT SWITCH (Commutateur de sélection de canal) (17)**

Permet la sélection des canaux "Ultra" ou "Clean". La position "Out" active le canal "Clean".

**NOTE:** La sélection de canal peut aussi s'effectuer à distance à l'aide de l'interrupteur au pied. Pour que la sélection à distance soit possible, le sélecteur être en position "In" (Ultra).

### **BRIGHT SWITCH (Sélecteur de brillance) (18)**

Produit un renforcement des fréquences aiguës. Pour activer, enclenchez le bouton à la position "In". Cette fonction de brillance n'affecte que le canal "Clean".

### **CLEAN GAIN (19)**

Contrôle le niveau de volume du canal.

### **LOW GAIN INPUT (Entrée faible Gain) (20)**

Cette prise accepte les instruments à très haut niveau de sortie qui causeraient de la saturation (distorsion) sur l'entrée "High Gain". Si les deux entrées sont utilisées simultanément, les niveaux sont alors équivalents ("Low Gain").

### **HIGH GAIN INPUT (Entrée haut gain) (21)**

Cette prise s'utilise avec la plupart des guitares électriques. Elle donne un gain supérieur de 6dB à l'entrée "Low Gain".

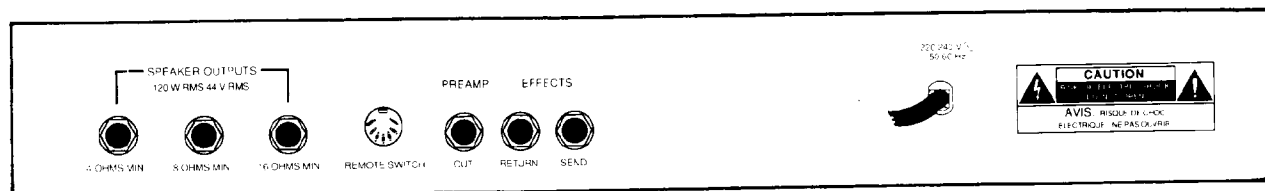

### **SPEAKER OUTPUTS (Sorties de haut-parleur) (22)**

Prises de sortie jack ¼" (6,35mm) pour haut-parleurs 4 ohms, 8 ohms, et 16 ohms. Lorsque les prises 8 et 16 ohms sont utilisées, l'impédance de l'amplificateur est de 8 ohms. Quand les prises 4 et 8 ohms sont utilisées, l'impédance de l'amplificateur est de 4 ohms

### **REMOTE FOOTSWITCH JACK (Jack pour interrupteur au pied) (23)**

Permet de brancher la commande à distance incluse. L'interrupteur au pied est utilisé pour sélectionner les canaux "Ultra Gain", "Crunch Gain", ou "Normal".

**PREAMP OUT (Sortie préampli) (24)**

La sortie préampli peut être utilisée pour amener le signal à une table de mixage, un magnétophone, etc. Utilisez des câbles blindés pour brancher la sortie du préampli à l'entrée d'un magnétophone, d'un mélangeur, etc. Ce branchement n'affecte pas le fonctionnement de l'amplificateur.

**EFFETCS RETURN (Retour d'effets) (25)**

Prise d'entrée pour signaux provenant d'appareils externes de traitement de signal ou d'effets à bas niveau.

**EFFECTS SEND (Envoi d'effets) (26)**

Prise de sortie servant à fournir des signaux à des appareils externes de traitement de signal ou d'effets à bas niveau.

**GROUND SWITCH (Sélecteur de mise à terre) (27)**

Commutateur rotatif à trois positions devant, la plupart du temps, être en position centrale (zéro). Dans certaines situations un bruit de ronflement ou un bourdonnement audible peut provenir des haut-parleurs de puissance. Dans ce cas, bougez le sélecteur de mise à terre jusqu'en position positive ou négative ( + ou -) ou jusqu'à ce que le bruit diminue.

**NOTE:** Si le problème de bruit persiste, consultez votre détaillant autorisé Peavey, la fabrique Peavey, ou un technicien de service qualifié. LE SÉLECTEUR DE MISE À TERRE NE FONCTIONNE PAS SUR LES APPAREILS 220/240 VOLT.

**LINE CORD (120V products only) (Cordon d'alimentation pour appareils 120V seulement) (28)**

Pour votre sécurité, nous avons incorporé un câble d'alimentation secteur à 3 fils avec mise-à-terre appropriée. Il n'est pas recommandé d'enlever la broche de mise-à-terre en aucune circonstance. S'il est nécessaire d'utiliser l'équipement sans mise-à-terre appropriée, utilisez des adaptateurs de mise-à-terre convenables. Une bonne mise-à-terre amoindrit le bruit de fond et réduit grandement les risques de choc.

# DEUTSCH

**Siehe diagramm der frontplatte im englischen teil des handbuchs.**

## **POWER SWITCH (Netzschalter) (1)**

Bringen Sie den Schalter auf die ON-Position. Die rote Kontrolllampe (LED) leuchtet und zeigt an, daß das Gerät eingeschaltet ist.

## **STANDBY SWITCH (2)**

Ermöglicht es, den Verstärker mit abgeschaltetem Tonsignal betriebsbereit zu halten. In der "Standby" Betriebsart werden die Röhren weiter beheizt, das Signal ist jedoch abgeschaltet.

## **POWER LED (3)**

Zeigt die eingeschaltete Netzspannung an.

## **STATUS LED (4)**

Leuchtet auf, wenn der Verstärker auf Standby steht und zeigt an, daß er nicht arbeitet.

## **MASTER LEVEL (5)**

Regelt die Gesamtlautstärke des Geräts. Wenn die gewünschte Balance der Clean, Crunch und Ultra-Kanäle erreicht ist, kann die Gesamtlautstärke des Geräts mit diesem Master Level Regler angehoben oder abgesenkt werden.

## **REVERB LEVEL (6)**

Eingebautes Echo-Hall-System. In Uhrzeigerrichtung drehen, um den Effekt zu verstärken. Fernbedienungs Fußschalter zum Ein- und Ausschalten des Effekts.

## **EDGE (7)**

Ein aktiver Klangregler (shelving Type,  $\pm 15$  dB), der die hohen Frequenzen anhebt oder absenkt.

**MERKE:** Dieser Regler wirkt nicht auf dem Clean-Kanal.

## **BODY (8)**

Ein aktiver Klangregler (peak/notch,  $\pm 15$  dB), der die Mittenfrequenzen anhebt oder absenkt.

**MERKE:** Dieser Regler wirkt nicht auf dem Clean-Kanal.

## **BOTTOM (9)**

Ein aktiver Klangregler (shelving Type,  $\pm 15$  dB), der die tiefen Frequenzen anhebt oder absenkt.

**MERKE:** Dieser Regler wirkt nicht auf dem Clean-Kanal.

## **POST GAIN (10)**

Regelt die Gesamtlautstärke des Kanals. Die Feineinstellung sollte erfolgen, wenn der gewünschte Klang erreicht wurde.

## **PRE GAIN (11)**

Regelt die Eingangsempfindlichkeit des Kanals.

## **CRUNCH GAIN SWITCH (12)**

Hebt generell die Lautstärke des Crunch-Kanals an. Zum Einschalten in die "in" Position bringen.

## **ULTRA GAIN SWITCH (13)**

Hebt generell die Lautstärke des Ultra-Kanals an. Zum Einschalten in die "in" Position bringen.

### **POST GAIN (14)**

Regelt die Gesamtlautstärke des Kanals. Die Feineinstellung sollte erfolgen, wenn der gewünschte Klang erreicht wurde.

### **PRE GAIN (15)**

Regelt die Eingangsempfindlichkeit des Kanals.

### **LOW, MID & HIGH EQ (16)**

Hierbei handelt es sich um passive Klangregler, die tiefe, mittlere und hohe Frequenzen entsprechend regeln.

### **CHANNEL SELECT SWITCH (17)**

Wählt den "Ultra" oder "Clean"-Kanal an. Die "Out" Position wählt "Clean" an.

**MERKE:** Kanalwahl kann ebenfalls per Fußschalter erfolgen. Ist dies gewünscht, muß der Schalter sich in der "in" Position (Ultra) befinden.

### **BRIGHT SWITCH (18)**

Bringt einen voreingestellten Boost der hohen Frequenzen. Zum Einschalten den Schalter in die "in" Position bringen. Die "Bright"-Funktion wirkt nur auf den "Clean" Kanal.

### **CLEAN GAIN (Gain) (19)**

Regelt die Lautstärke des Kanals.

### **LOW GAIN INPUT (20)**

Dieser Eingang ist für die Instrumente vorgesehen, die ein besonders hohes Ausgangssignal erzeugen. Falls beide Eingänge gleichzeitig benutzt werden, sind die Ausgangssignale gleich (beide sind dann Low Gain).

### **HIGH GAIN INPUT (21)**

Dieser Eingang kann für die meisten elektrischen Gitarren verwendet werden. Er ist 6 dB empfindlicher als der Low Gain Input.

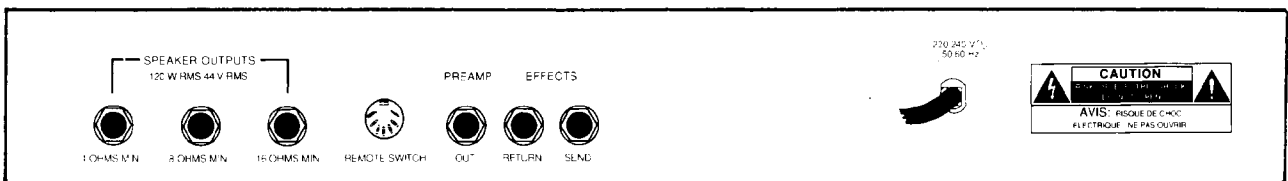

### **SPEAKER OUTPUTS (22)**

Klinkenausgangsbuchsen stehen zur Verfügung für 4 Ohm, 8 Ohm und 16 Ohm. Wenn die 8 und 16 Ohm Buchsen belegt sind, beträgt die Impedanz des Verstärkers 8 Ohm. Wenn die 4 und 8 Ohm Buchsen belegt sind, beträgt die Impedanz des Verstärkers 4 Ohm.

### **REMOTE FOOTSWITCH JACK (23)**

Zum Anschluß des mitgelieferten Fußschalters. Dieser dient zur Anwahl von Ultra Gain, Crunch Gain oder Normal Channels.

### **PREAMP OUT (Vorstufenausgang) (24)**

Dieser Ausgang kann zum Anschluß des Verstärkers an einen Mixer, eine Bandmaschine, etc. verwendet werden. Verbinden Sie den Ausgang mit Hilfe eines abgeschirmten Kabels mit dem Eingang des entsprechenden Gerätes. Dieser Anschluß beeinflusst die Funktionen des Verstärkers nicht.



**EFFECTS RETURN (25)**

Eingang für rückführende Signale von niederohmigen Effekten oder Signal-Prozessoren.

**EFFECTS SEND (26)**

Ausgang für Zuliefersignale zu externen niederohmigen Effekten oder Signal-Prozessoren.

**GROUND SWITCH (27)**

Der Ground-Schalter funktioniert nicht bei den 220/240 Volt-Modellen.

**LINE CORD (120V products only) (Nur bei 120 Volt-Geräten) (28)**

Zu Ihrer Sicherheit haben wir das Gerät mit einem dreiadrigen geerdeten Netzkabel versehen. Es ist unter keinen Umständen empfehlenswert den Erdungskontakt des Anschlußkabels zu lösen. Falls es notwendig sein sollte, das Equipment ohne die vorgesehene Erdung zu betreiben empfiehlt sich die Verwendung eines Grounding Adaptors. Die geringsten Störgeräusche und die höchste Sicherheit vor elektrischen Schlägen wird jedoch durch die Benutzung der vorgesehenen Erdungsmöglichkeiten erreicht.

**THIS LIMITED WARRANTY VALID ONLY WHEN PURCHASED AND REGISTERED IN THE UNITED STATES OR CANADA. ALL EXPORTED PRODUCTS ARE SUBJECT TO WARRANTY AND SERVICES TO BE SPECIFIED AND PROVIDED BY THE AUTHORIZED DISTRIBUTOR FOR EACH COUNTRY.**

**Ces clauses de garantie ne sont valables qu'aux Etats-Unis et au Canada. Dans tous les autres pays, les clauses de garantie et de maintenance sont fixées par le distributeur national et assues par lui selon la législation en vigueur.**

**Diese Garantie ist nur in den USA und Kanada gültig. Alle Export-Produkte sind der Garantie und dem Service des Importeurs des jeweiligen Landes unterworfen. Esta garantía es válida solamente cuando el producto es comprado en E.U. continentales o en Canada. Todos los productos que sean comprados en el extranjero, estan sujetos a las garantías y servicio que cada distribuidor autorizado determine y ofrezca en los diferentes países.**

**PEAVEY ONE-YEAR LIMITED  
WARRANTY/REMEDY**

PEAVEY ELECTRONICS CORPORATION ("PEAVEY") warrants this product, EXCEPT for covers, footswitches, patchcords, tubes and meters, to be free from defects in material and workmanship for a period of one (1) year from date of purchase, PROVIDED, however, that this limited warranty is extended only to the original retail purchaser and is subject to the conditions, exclusions, and limitations hereinafter set forth:

**PEAVEY 90-DAY LIMITED WARRANTY ON TUBES AND METERS**

If this product contains tubes or meters, Peavey warrants the tubes or meters contained in the product to be free from defects in material and workmanship for a period of ninety (90) days from date of purchase; PROVIDED, however, that this limited warranty is extended only to the original retail purchaser and is also subject to the conditions, exclusions, and limitations hereinafter set forth.

**CONDITIONS, EXCLUSIONS, AND LIMITATIONS OF LIMITED WARRANTIES**

These limited warranties shall be void and of no effect, if:

- a. The first purchase of the product is for the purpose of resale; or
- b. The original retail purchase is not made from an AUTHORIZED PEAVEY DEALER; or
- c. The product has been damaged by accident or unreasonable use, neglect, improper service or maintenance, or other causes not arising out of defects in material or workmanship; or
- d. The serial number affixed to the product is altered, defaced, or removed.

In the event of a defect in material and/or workmanship covered by this limited warranty, Peavey will:

- a. In the case of tubes or meters, replace the defective component without charge.
- b. In other covered cases (i.e., cases involving anything other than covers, footswitches, patchcords, tubes or meters), repair the defect in material or workmanship or replace the product, at Peavey's option; and provided, however, that, in any case, all costs of shipping, if necessary, are paid by you, the purchaser.

**THE WARRANTY REGISTRATION CARD SHOULD BE ACCURATELY COMPLETED AND MAILED TO AND RECEIVED BY PEAVEY WITHIN FOURTEEN (14) DAYS FROM THE DATE OF YOUR PURCHASE.**

In order to obtain service under these warranties, you must:

- a. Bring the defective item to any PEAVEY AUTHORIZED DEALER or AUTHORIZED PEAVEY SERVICE CENTER and present therewith the ORIGINAL PROOF OF PURCHASE supplied to you by the AUTHORIZED PEAVEY DEALER in connection with your purchase from him of this product.

If the DEALER or SERVICE CENTER is unable to provide the necessary warranty service you will be directed to the nearest other PEAVEY AUTHORIZED DEALER or AUTHORIZED PEAVEY SERVICE CENTER which can provide such service.

**OR**

- b. Ship the defective item, prepaid, to:

PEAVEY ELECTRONICS CORPORATION  
International Service Center  
Highway 80 East  
MERIDIAN, MS 39301

including therewith a complete, detailed description of the problem, together with a legible copy of the original PROOF OF PURCHASE and a complete return address. Upon Peavey's receipt of these items:

If the defect is remedial under these limited warranties and the other terms and conditions expressed herein have been complied with, Peavey will provide the necessary warranty service to repair or replace the product and will return it, FREIGHT COLLECT, to you, the purchaser.

Peavey's liability to the purchaser for damages from any cause whatsoever and regardless of the form of action, including negligence, is limited to the actual damages up to the greater of \$500.00 or an amount equal to the purchase price of the product that caused the damage or that is the subject of or is directly related to the cause of action. Such purchase price will be that in effect for the specific product when the cause of action arose. This limitation of liability will not apply to claims for personal injury or damage to real property or tangible personal property allegedly caused by Peavey's negligence. Peavey does not assume liability for personal injury or property damage arising out of or caused by a non-Peavey alteration or attachment, nor does Peavey assume any responsibility for damage to interconnected non-Peavey equipment that may result from the normal functioning and maintenance of the Peavey equipment.

**UNDER NO CIRCUMSTANCES WILL PEAVEY BE LIABLE FOR ANY LOST PROFITS, LOST SAVINGS, ANY INCIDENTAL DAMAGES, OR ANY CONSEQUENTIAL DAMAGES ARISING OUT OF THE USE OR INABILITY TO USE THE PRODUCT, EVEN IF PEAVEY HAS BEEN ADVISED OF THE POSSIBILITY OF SUCH DAMAGES.**

THESE LIMITED WARRANTIES ARE IN LIEU OF ANY AND ALL WARRANTIES, EXPRESSED OR IMPLIED, INCLUDING, BUT NOT LIMITED TO, THE IMPLIED WARRANTIES OF MERCHANTABILITY AND FITNESS FOR A PARTICULAR USE; PROVIDED, HOWEVER, THAT IF THE OTHER TERMS AND CONDITIONS NECESSARY TO THE EXISTENCE OF THE EXPRESSED, LIMITED WARRANTIES, AS HEREINABOVE STATED, HAVE BEEN COMPLIED WITH, IMPLIED WARRANTIES ARE NOT DISCLAIMED DURING THE APPLICABLE ONE-YEAR OR NINETY-DAY PERIOD FROM DATE OF PURCHASE OF THIS PRODUCT.

SOME STATES DO NOT ALLOW LIMITATION ON HOW LONG AN IMPLIED WARRANTY LASTS, OR THE EXCLUSION OR LIMITATION OF INCIDENTAL OR CONSEQUENTIAL DAMAGES, SO THE ABOVE LIMITATIONS OR EXCLUSIONS MAY NOT APPLY TO YOU. THESE LIMITED WARRANTIES GIVE YOU SPECIFIC LEGAL RIGHTS, AND YOU MAY ALSO HAVE OTHER RIGHTS WHICH MAY VARY FROM STATE TO STATE.

THESE LIMITED WARRANTIES ARE THE ONLY EXPRESSED WARRANTIES ON THIS PRODUCT, AND NO OTHER STATEMENT, REPRESENTATION, WARRANTY, OR AGREEMENT BY ANY PERSON SHALL BE VALID OR BINDING UPON PEAVEY.

In the event of any modification or disclaimer of expressed or implied warranties, or any limitation of remedies, contained herein conflicts with applicable law, then such modification, disclaimer or limitation, as the case may be, shall be deemed to be modified to the extent necessary to comply with such law.

Your remedies for breach of these warranties are limited to those remedies provided herein and Peavey Electronics Corporation gives this limited warranty only with respect to equipment purchased in the United States of America.

**INSTRUCTIONS — WARRANTY REGISTRATION CARD**

1. Mail the completed WARRANTY REGISTRATION CARD to:

PEAVEY ELECTRONICS CORPORATION  
POST OFFICE BOX 2898  
MERIDIAN, MISSISSIPPI 39302-2898

- a. Keep the PROOF OF PURCHASE. In the event warranty service is required during the warranty period, you will need this document. **There will be no identification card issued by Peavey Electronics Corporation.**
2. IMPORTANCE OF WARRANTY REGISTRATION CARDS AND NOTIFICATION OF CHANGES OF ADDRESSES:
  - a. Completion and mailing of WARRANTY REGISTRATION CARDS — Should notification become necessary for any condition that may require correction, the REGISTRATION CARD will help ensure that you are contacted and properly notified.
  - b. Notice of address changes — If you move from the address shown on the WARRANTY REGISTRATION CARD, you should notify Peavey of the change of address so as to facilitate your receipt of any bulletins or other forms of notification which may become necessary in connection with any condition that may require dissemination of information or correction.
3. You may contact Peavey directly by telephoning (601) 483-5365.

## IMPORTANT SAFETY INSTRUCTIONS

**WARNING** When using electric products, basic cautions should always be followed, including the following.

1. Read all safety and operating instructions before using this product.
2. All safety and operating instructions should be retained for future reference.
3. Obey all cautions in the operating instructions and on the back of the unit.
4. All operating instructions should be followed.
5. This product should not be used near water, i.e., a bathtub, sink, swimming pool, wet basement, etc.
6. This product should be located so that its position does not interfere with its proper ventilation. It should not be placed flat against a wall or placed in a built-in enclosure that will impede the flow of cooling air.
7. This product should not be placed near a source of heat such as a stove, radiator, or another heat producing amplifier.
8. Connect only to a power supply of the type marked on the unit adjacent to the power supply cord.
9. Never break off the ground pin on the power supply cord. For more information on grounding, write for our free booklet "Shock Hazard and Grounding."
10. Power supply cords should always be handled carefully. Never walk or place equipment on power supply cords. Periodically check cords for cuts or signs of stress, especially at the plug and the point where the cord exits the unit.
11. The power supply cord should be unplugged when the unit is to be unused for long periods of time.
12. If this product is to be mounted in an equipment rack, rear support should be provided.
13. Metal parts can be cleaned with a damp rag. The vinyl covering used on some units can be cleaned with a damp rag, or an ammonia-based household cleaner if necessary. Disconnect unit from power supply before cleaning.
14. Care should be taken so that objects do not fall and liquids are not spilled into the unit through the ventilation holes or any other openings.
15. This unit should be checked by a qualified service technician if
  - a. The power supply cord or plug has been damaged.
  - b. Anything has fallen or been spilled into the unit.
  - c. The unit does not operate correctly.
  - d. The unit has been dropped or the enclosure damaged.
16. The user should not attempt to service this equipment. All service work should be done by a qualified service technician.
17. This product should be used only with a cart or stand that is recommended by Peavey Electronics.
18. Exposure to extremely high noise levels may cause a permanent hearing loss. Individuals vary considerably in susceptibility to noise induced hearing loss, but nearly everyone will lose some hearing if exposed to sufficiently intense noise for a sufficient time.

The U.S. Government's Occupational Safety and Health Administration (OSHA) has specified the following permissible noise level exposures

Duration Per Day In Hours	Sound Level dBA, Slow Response
8	90
6	92
4	95
3	97
2	100
1½	102
1	105
½	110
¼ or less	115

According to OSHA, any exposure in excess of the above permissible limits could result in some hearing loss.

Ear plugs or protectors in the ear canals or over the ears must be worn when operating this amplification system in order to prevent a permanent hearing loss if exposure is in excess of the limits as set forth above. To ensure against potentially dangerous exposure to high sound pressure levels, it is recommended that all persons exposed to equipment capable of producing high sound pressure levels such as this amplification system be protected by hearing protectors while this unit is in operation.

**SAVE THESE INSTRUCTIONS**



Features and specifications subject to change without notice.

**Peavey Electronics Corporation** 711 A Street / Meridian, MS 39302-2898 / U.S.A. / (601) 483-5365 / Telex 504115 / Fax 484-4278

©1992

#80301360

Printed in U.S.A. 7/92